





PROFESSIONAL OFFICE  
**PROF**

---

20  
YEARS  
YOUNG

OPENWALL



---

OFFICE  
COMPANY

---

Dall'esperienza nel settore del mobile, nel 1995 nasce Prof, una realtà industriale familiare che produce sistemi d'arredo per ufficio, fortemente radicata nel distretto del mobile del nord est italiano. In questi vent'anni il percorso di sviluppo e crescita economica di Prof l'ha condotta ad affacciarsi al mercato internazionale, contribuendo a diffondere la qualità del design italiano nel mondo. Avvalendosi della consulenza di architetti e designer, l'azienda ha consolidato la propria identità e ampliato l'offerta di prodotti. Partendo dalle collezioni operative, ha sviluppato in seguito sistemi direzionali, soluzioni per la reception e le sale riunioni, fino alle pareti divisorie e attrezzate. Questo oggi le permette di proporre soluzioni di arredo complete e personalizzate per tutti gli ambienti di lavoro.

Prof was born in 1995 from the furniture sector experience, a family industrial reality that produces office furniture systems, deep-rooted in the Italian north-east furniture district. In these twenty years, Prof economic route of development and growth allowed it to look out to the international market contributing to the Italian quality design diffusion in the world.

Taking advantage from architects and designer consultancy, Prof strengthened its identity and it widened the products offer. Beginning from the secretarial collections, it then developed executive systems, reception and conference rooms solutions, getting up to separating and equipped wall. Today, this allows it to propose complete and customized furnishing solution for any working site.

---

---

# HOW WE WORK

OPENWALL



---

## OFFICE DESIGN

In Prof ogni elemento d'arredo nasce dalla capacità di interpretare il continuo mutamento delle dinamiche negli ambienti di lavoro. La ricerca rappresenta da sempre l'elemento strategico nella politica di crescita aziendale e si esprime attraverso un Design Department interno, che opera a stretto contatto con i progettisti esterni ed è in costante aggiornamento con l'evoluzione tecnologica e normativa.

I prodotti Prof sono progettati e interamente realizzati in Italia, nel pieno rispetto degli standard europei in materia di salute e sicurezza nei luoghi di lavoro.

Per questo motivo le collezioni Prof si distinguono per il design, l'ergonomia e la funzionalità.

In Prof company, any furnishing element rises from the ability to understand the constantly changing of the working places dynamics. The research has always represented the strategic element of the company policy of business growth and it expresses through an internal Design Department working closely in contact with external designers and it is constantly updating with the technological and legislative evolution.

Prof models are entirely designed and manufactured in Italy, in full compliance with European standards concerning the health and safety in the workplace.

For this reason, Prof collections stand out for the design, the ergonomics and the functionality.

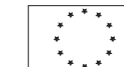

---

OFFICE  
QUALITY AND ENVIROMENT

---

Per rispondere alla crescente competitività nei mercati internazionali attraverso il miglioramento della soddisfazione e della fidelizzazione dei clienti, la razionalizzazione dei processi produttivi interni, Prof ha ottenuto nel 2012 la certificazione ISO 9001:2008. L'adozione di un sistema di gestione per la qualità rappresenta per Prof una decisione strategica che consente di raggiungere obiettivi aziendali sempre più concreti.

In un mondo costantemente alla ricerca della qualità e sempre più sensibile alle problematiche ecologiche, Prof mette in campo la massima professionalità nel progettare e produrre mobili per ufficio rispettando l'ambiente. Dalla materia prima accuratamente selezionata, all'intero processo di trasformazione e imballaggio, fino allo smaltimento, tutto è finalizzato alla salvaguardia della salute ed al risparmio energetico. L'ottenimento nel 2012 della certificazione ISO 14001 ne dimostra l'impegno concreto. Nel 2015, in concomitanza con i venti anni dell'azienda, Prof lancia il suo nuovo marchio green per riconfermare e rendere riconoscibile il suo impegno verso il tema della sostenibilità ambientale, come parte integrante della propria attività e del proprio processo di crescita produttiva.



In order to answer to the increasing competitiveness of the international markets through the improvement of the customer satisfaction and loyalty, the rationalizing of the internal producing processes, Prof attained ISO 9001:2008 certification in 2012. The adoption of a quality management system represents for Prof a strategic decision giving the possibility to achieve business objectives more and more concrete.

In a world steadily looking for the quality and increasingly sensible to ecological problems, Prof puts in place the maximum expertise in the office furniture design and production while respecting the environment. Starting from the carefully selected raw material, the whole process of transformation and packaging up to the disposal, all aims at the health safeguarding and at energy saving. In 2012, the obtainment of ISO 14001 certification demonstrates the concrete commitment. In 2015, at the same time of the company twenty years, Prof launches its new green mark to confirm and make identifiable its commitment towards the environmental sustainability as integral part of its activity and of its process of production growth.



WE  
CARE

CONTENTS

—

**10 \_ 11**

OPENWALL

**12 \_ 19**

OFFICE  
PROJECT 01

**20 \_ 27**

OFFICE  
PROJECT 02

**28 \_ 35**

OFFICE  
PROJECT 03

**36 \_ 43**

OFFICE  
PROJECT 04

**44 \_ 51**

OFFICE  
PROJECT 05

**52 \_ 59**

OFFICE  
PROJECT 06

**60 \_ 67**

OFFICE  
PROJECT 07

**68 \_ 75**

OFFICE  
PROJECT 08

**76 \_ 83**

OFFICE  
PROJECT 09

**85 \_ 95**

FINISHINGS AND  
TECHNICAL DATA

---

## OPENWALL WORKING COLLECTION

---

Openwall è un sistema di partizione flessibile composto da elementi modulari disponibili in due altezze e otto larghezze. E' caratterizzato da un telaio metallico con cremagliere verniciato bianco opaco dal disegno essenziale e da una struttura a sandwich di 9 cm di spessore con pannelli in legno, vetro o rivestiti in tessuto. Uno speciale vano tecnico lineare nasconde e contiene la canalizzazione, contribuendo a creare un'estetica pulita. Facilmente attrezzabile con piani di lavoro e di servizio, Openwall soddisfa le esigenze lavorative destinate ad attività individuali e sociali condivise.

In versione free-standing può fungere da elemento divisorio tra diverse aree di lavoro, oppure configurare uffici indipendenti a cellule chiuse.

Una serie di componenti ausiliari come mensole, contenitori appesi e barra porta accessori garantisce massimo comfort e funzionalità alla postazione di lavoro.

Ampia possibilità di scelta e personalizzazione di colori e finiture, che vanno dalle tinte unite ai legni, fino ai tessuti che offrono un migliore benessere acustico, per svolgere il proprio lavoro con concentrazione e libertà creativa.

Openwall is a system of flexible partition consisting of modular elements available in two heights and eight widths. It is characterized by a matt white varnished metal frame with racks by the essential design and by a sandwich structure 9 cm thick with wood, glass or fabric covered panels.

A special technical linear compartment hides and contains the channeling, helping to create a clean aesthetic.

Easily equipped with work and extension tops, Openwall meets the business needs for the individual and the shared social activities. In free-standing version it can serve as a divider between different work areas, or set up independent offices as closed cell.

A set of auxiliary components such as shelves, hanging cabinets and bars for accessories offers more comfort and functionality to the workstation.

Wide choice and customization of colors and finishes, ranging from solid colors to wood or fabrics that allows an improved acoustic comfort, to work with concentration and creative freedom.

---

design R&S Prof





OFFICE  
PROJECT 01

Postazioni singole realizzate con moduli Openwall H.1661 mm connessi con nodo a 2 vie 90°. Piano scrivania appeso su staffe e dattilo su cassetiera portante.

Individual workstations built with Openwall modules H.1661 mm connected with 2-way 90° joint. Desk top on hanging brackets and top extension on supporting drawer unit.

<b>F</b>	Bianco	White
	Curry	Curry
	Beige	Beige
	Cipria	Powder pink

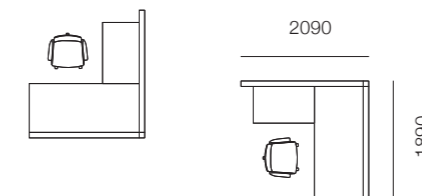



OPENWALL

PROJECT 01





Nell'altezza 1661 mm, il lato interno e quello esterno possono essere diversamente ripartiti con due o tre pannelli orizzontali, da caratterizzare con fasce alternate di colore o in tinta unita.

On 1661 mm in height, the inside and the outside side can be otherwise shared with two or three horizontal panels, to be characterized by alternating bands of color or monochrome.



OFFICE  
PROJECT 02

Postazioni doppie realizzate con moduli Openwall H.1661 mm connessi con nodo a 3 vie 90°.  
Piano di lavoro sagomato appeso su staffe e cassetteria portante; come accessori mensole metalliche e contenitori con anta a vela.

Double workstations built with Openwall modules H.1661 mm connected with 3-way 90° joint.  
Shaped worktop hung on brackets and supporting drawer unit; accessories like metal shelves and suspended cabinets with tilt door.

<b>F</b>	Bianco	White
	Beige	Beige
	Cipria	Powder pink
	Rame	Copper

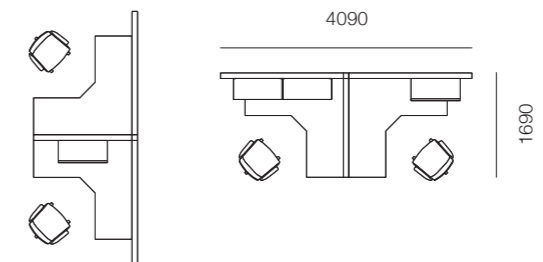





Contenitori appesi e mensole metalliche possono essere liberamente posizionati lungo tutta la lunghezza della parete.

Hanging cabinets and metal shelves can be freely positioned along the entire length of the partition wall.





OFFICE  
PROJECT 03

Configurazione a stella con moduli Openwall H.1661 mm connessi con nodo a 4 vie 90°. Piano di lavoro appeso su staffe e piano di servizio su cassetteria portante. Personalizzata con mensole in legno, barra porta accessori e contenitori con anta a vela.

Star configuration with Openwall modules H.1661 mm connected with 4-way 90° joint. Hanging work top on brackets and top extension on supporting drawer unit. Personalized with wooden shelves, aluminium bar for accessories and cabinets with tilt door.

<b>F</b>	Bianco	White
	Olmo	Elm
	Beige	Beige
	Grigio	Grey

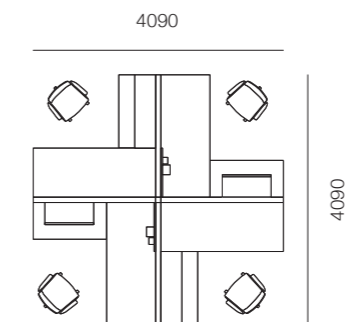



OPENWALL

PROJECT 03



Dettaglio delle mensole in legno con staffe agganciate alle cremagliere del modulo Openwall. Elementi mobili liberamente posizionabili all'altezza desiderata. Pareti interamente rivestite in tessuto per un migliore comfort acustico.

Details of wooden shelves with brackets fixed to the racks of the Openwall module. Moving parts freely positioned at the desired height. Partition walls entirely covered in fabric for a better acoustic comfort.





Contenitore appeso con anta a vela per archiviare documenti e dox, disponibile anche con barra led. Barra porta oggetti agganciata alle cremagliere del modulo Openwall, utilizzata in combinazione con una collezione di accessori dedicati.

Suspended cabinet with tilt door to store documents and dox, also available with LED bar. Accessories hanging bar fixed to the racks of the Openwall module, used in combination with a collection of dedicated accessories.



OFFICE  
PROJECT 04

Postazione doppia con piano dattilo centrale condiviso.  
Combina moduli Openwall nelle due altezze H.1661 mm  
e H.1277 mm con nodo di connessione a 2 vie 90°.

Double workstation with a central shared top extension.  
Combine Openwall modules in two heights H.1661 mm  
and H.1277 mm connected with 2-way 90° joint.

F Bianco White  
Beige Beige  
Grigio Grey

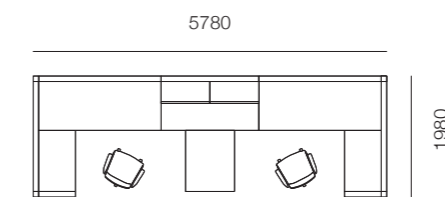



OPENWALL

PROJECT 04





La combinazione dei moduli Openwall nelle due diverse altezze consente di creare delle configurazioni con diversi livelli di privacy.

The combination of the Openwall modules in two different heights allows to create configurations with different levels of privacy.





OFFICE  
PROJECT 05

Configurazione in linea con parete centrale elettrificata H.1661 mm e pareti laterali H.1277 mm che definiscono postazioni singole e condivise. Connessioni con nodi a 3 e 4 vie 90°.

Linear configurations with electrified partition wall H.1661 mm and lateral partition walls H.1277 mm to generate individual and shared workstations. Connections with 3 and 4-way 90° joints.

<b>F</b>	Bianco	White
	Beige	Beige
	Petrolio	Petroleum
	Vetro satinato	Satin glass

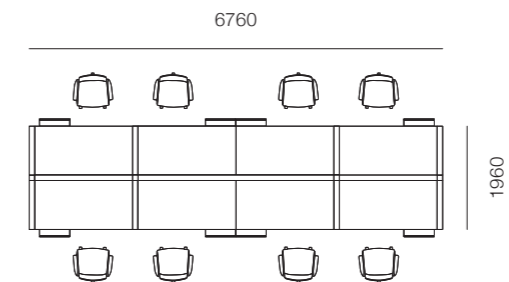

OPENWALL



PROJECT 05



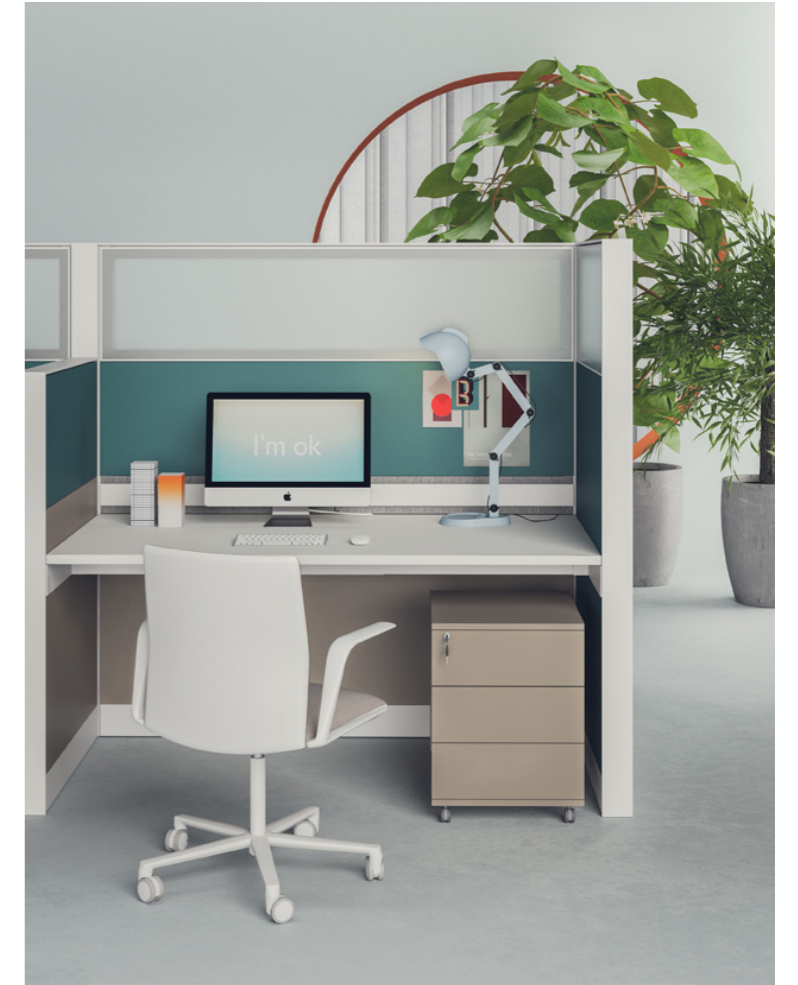

Le postazioni sono divise da elementi del sistema Openwall con pannelli superiori in vetro satinato, per mantenere la privacy visiva e consentire il passaggio dell'illuminazione naturale.

The workstations are divided by elements of Openwall system with upper panels in satin glass, to maintain the visual privacy and allow the passage of natural lighting.



OFFICE  
PROJECT 06

Postazioni multiple con parete centrale H.1661 mm e laterale elettrificata H.1277 mm connesse con nodo a 4 vie. Piani da un lato appesi alla parete e in appoggio ai contenitori Service unit dall'altro.

Multiple workstations with central partition wall H.1661 mm and electrified lateral partition wall H.1277 mm connected with 4-way 90° joint. Desk tops fixed to the partition wall on one side and in support to the Service unit cabinets on the other.

F	Grigio	Grey
	Tabacco	Tobacco
	Curry	Curry

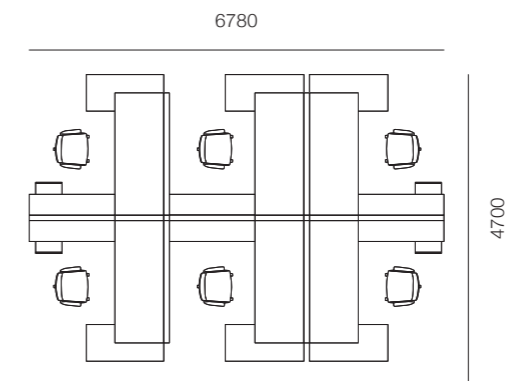



OPENWALL

PROJECT 06





I moduli H.1661 mm sono caratterizzati dal pannello superiore in vetro trasparente e attrezzati con mensole che espandono la superficie del piano di lavoro.

The modules H. 1661 mm are characterized by a top panel in transparent glass and equipped with shelves that expand the surface of the working top.



OFFICE  
PROJECT 07

Elementi Openwall H.1661 mm in versione free-standing definiscono funzioni diverse all'interno di un unico ambiente di lavoro: da un lato un'informale area meeting e dall'altro una postazione di lavoro individuale.

Openwall elements H.1661 mm in free-standing version define different functions within a single working environment: on one side an informal meeting area and on the other an individual workplace.

<b>F</b>	Bianco	White
	Cipria	Powder pink
	Olmo	Elm
	Petrolio	Petroleum
	Visone	Mink

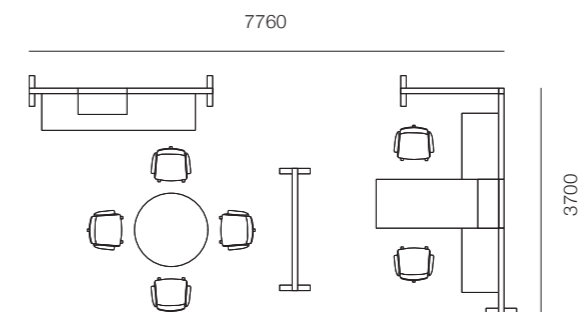





Parete divisoria free-standing H. 1661 mm  
realizzata con due pannelli orizzontali rivestiti in  
tessuto visone.

Free-standing partition wall H. 1661 mm made of  
two horizontal panels covered with visone fabric.





La flessibilità del sistema Openwall consente di elettrificare anche solo un lato di un singolo modulo, per portare i cablaggi laddove necessario.

The flexibility of the Openwall system allows to electrify also only one side of a single module, to bring the wiring where needed.



OFFICE  
PROJECT 08

Moduli Openwall H.1661 mm in versione free-standing per creare uffici privati destinati all'accoglienza con una scrivania libera e una integrata alla parete.

Openwall modules H.1661 mm in free-standing version create private offices for the reception with a stand alone desk and a wall mounted desk.

F Noce Walnut  
Basalto Basalt  
Rame Copper

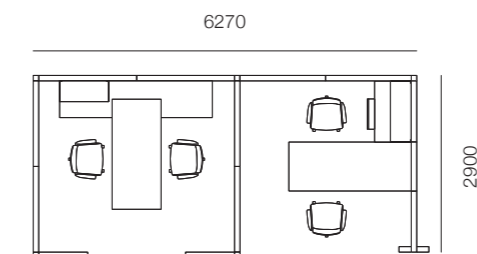



OPENWALL

PROJECT 08





La modularità orizzontale permette l'alternanza tra pareti cieche ed elettrificate, mantenendo lo stesso aspetto e rigore formale.

The horizontal modularity allows the alternation between solid and electrified partition walls, retaining the same appearance and formal rigor.



OFFICE  
PROJECT 09

Soluzione con partizioni H.1661 mm che individuano macro aree di lavoro all'interno di un unico openspace, combinate a moduli H.1227 mm che separano le singole postazioni.

Solution with partitions H.1661 mm which identify macro work areas within a single openspace, combined with modules H.1227 mm which separate the individual workstations.

F	Grigio	Grey
	Rosso	Red
	Rame	Copper

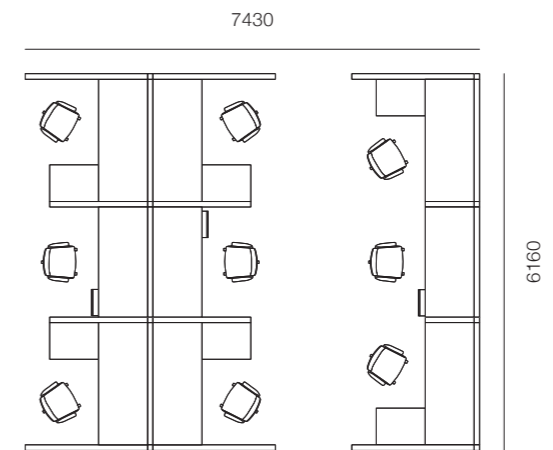





Openwall diventa parte integrante dell'architettura degli interni, scadendo gli spazi con aree di passaggio dall'aspetto omogeneo e aree interne di lavoro liberamente personalizzabili.

Openwall becomes an integral part of the interior architecture, running out the spaces with looking homogeneous passing areas and freely customizable inland areas of work.





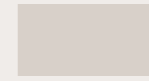

FINISHINGS

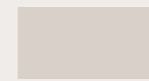
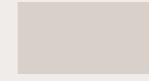

## FINITURA MELAMINICO MELAMINE FINISHING

Pannelli in fibre legnose classe E1 a bassa emissione di formaldeide e in classe di resistenza al fuoco 2, con rivestimento melaminico antigraffio, anticorrosione, antiriflesso. Bordi in ABS in tinta con la superficie.

Wooden fiber panels class E1 low emission of formaldehyde and class 2 fire resistance with an anti-scratch, anti-corrosion, anti-reflex melamine covering. Edges in ABS with colour matching the surface.



## VETRO GLASS

spessore 4 mm / 4 mm thick



00 trasparente  
00 transparent

02 satinato  
02 satin

## METALLO OPACO MATT METAL

acciaio verniciato a polveri / powder coated steel



20 bianco opaco  
20 matt white

## TESSUTO FABRIC

### MIRAGE

100% poliestere FR (Tr Cs) / 100% polyester FR (Tr Cs)

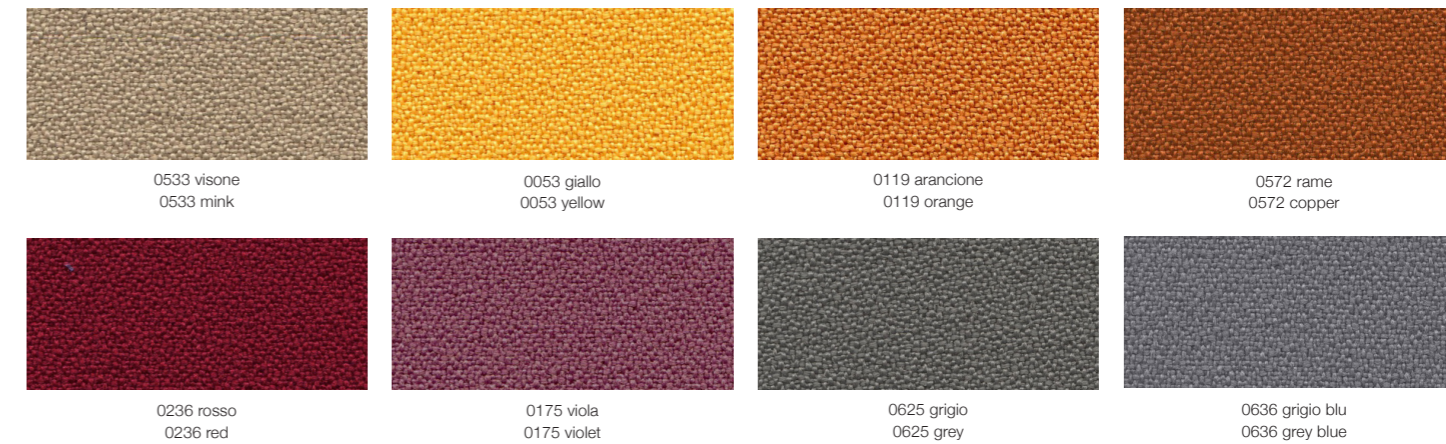

### TREVI

100% poliestere FR (Tr Cs) / 100% polyester FR (Tr Cs)

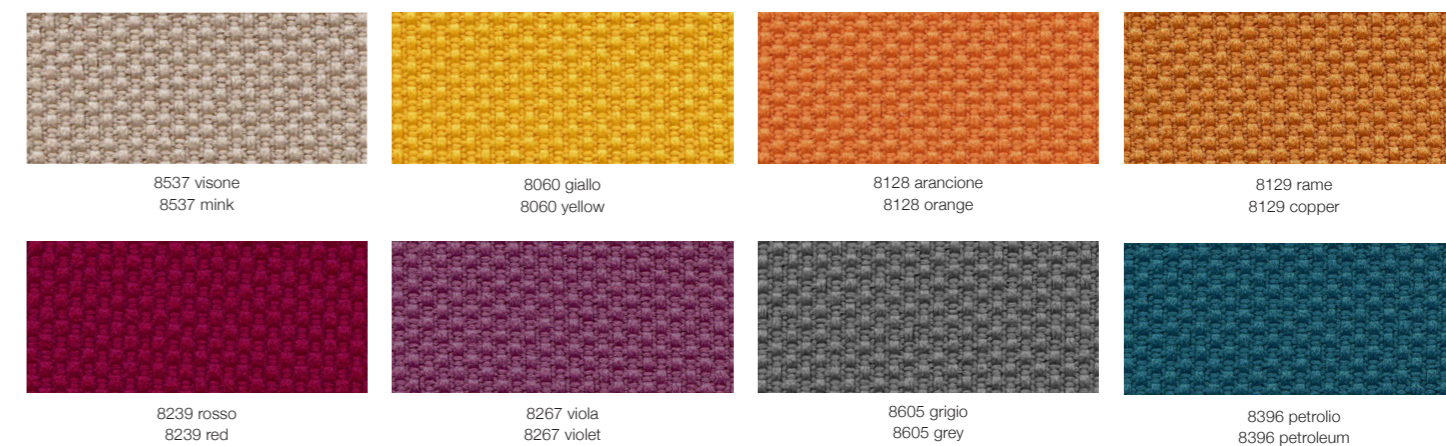

### FENICE

75% lana - 25% poliammide / 75% wool - 25% polyamide

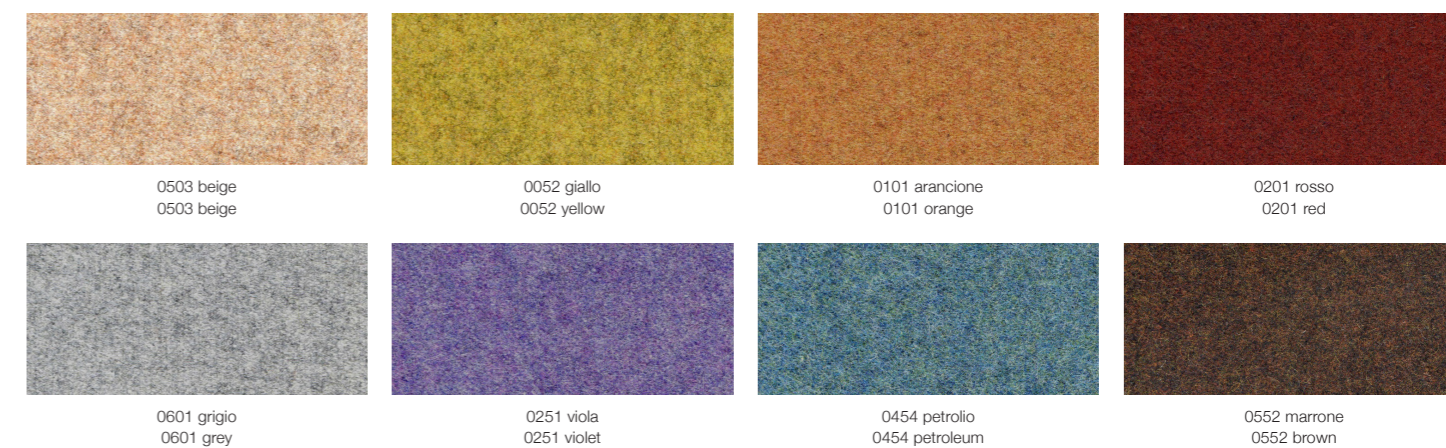

OPENWALL

Colori e materiali hanno valore indicativo / colours and materials have an indicative value

FINISHINGS

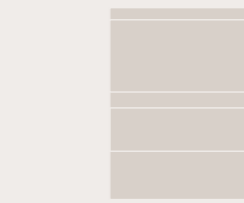

TECHNICAL DATA

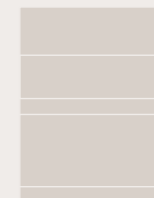
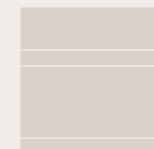

## MODULARITÀ E CONNESSIONI MODULARITY AND CONNECTIONS

Openwall è un sistema modulare in altezza e larghezza, che permette soluzioni personalizzate per ogni esigenza lavorativa.

Due sono le altezze e otto le larghezze disponibili. I moduli Openwall sono facilmente componibili in linea mediante giunto lineare o a 90° con nodo a 2, 3 o 4 vie.

Openwall is a modular system in height and width, which allows customized solutions for every working need.

Two heights and eight widths are available. The Openwall modules are easily assembled in line by a linear or 2, 3 or 4-way 90° joint.

OPENWALL

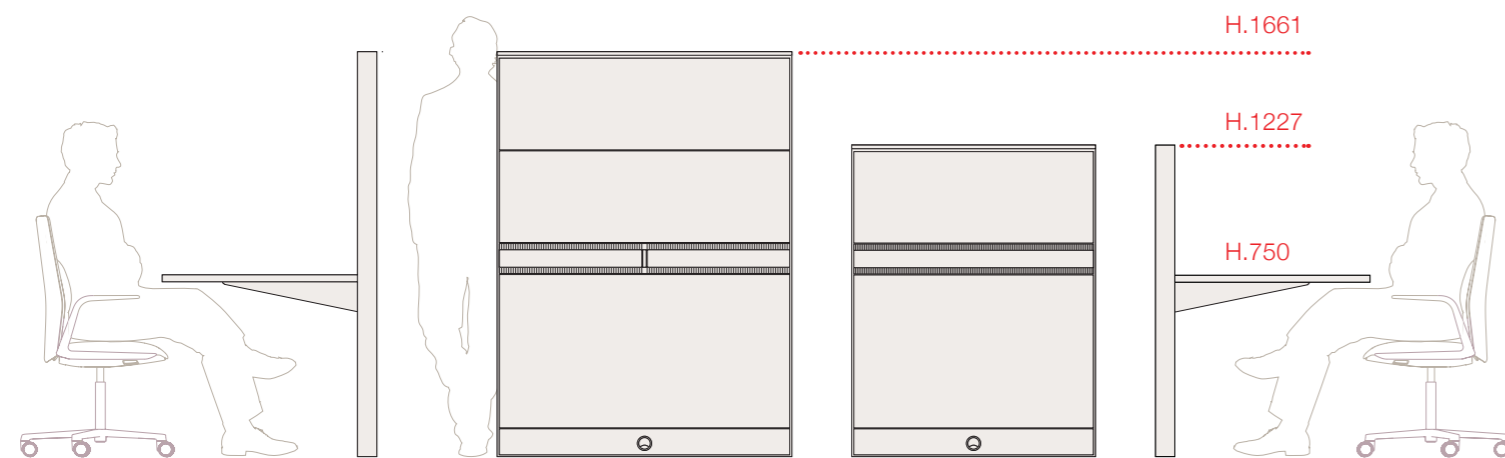

L. 600  
L. 800  
L.1000  
L.1200  
L.1400  
L.1600  
L.1800  
L.2000

Connessione lineare  
Linear connection



Nodo a 2 vie 90°  
2-way 90° joint



Nodo a 3 vie 90°  
3-way 90° joint



Nodo a 4 vie 90°  
4-way 90° joint

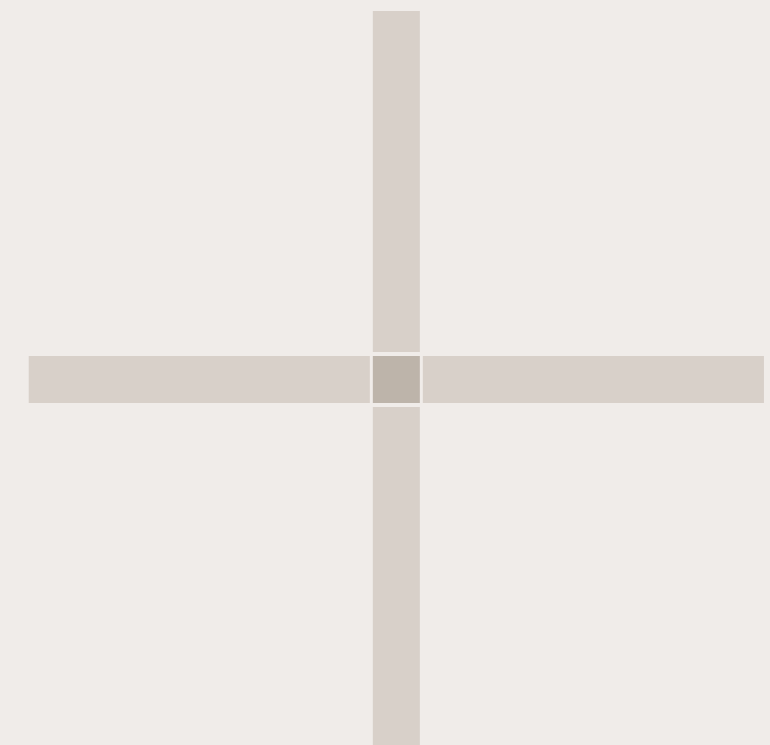

TECHNICAL DATA

CANALIZZAZIONE  
ORIZZONTALE E VERTICALE  
CABLE MANAGEMENT  
VERTICAL AND HORIZONTAL

I moduli Openwall permettono il passaggio e la distribuzione dei cavi sia verticalmente che orizzontalmente. L'ingresso avviene tramite uno speciale zoccolo con passacavi. Un'apposita anta metallica, posizionata immediatamente sopra il piano di lavoro, corre per tutta la lunghezza del modulo e consente facile accesso alle prese di corrente e dati.

The Openwall modules allow the passage and distribution of cables both horizontally and vertically. The entrance is via a special base board with cable tidy. A special metal door, positioned immediately above the working top, runs for the entire length of the module and allows easy access to power sockets and data.

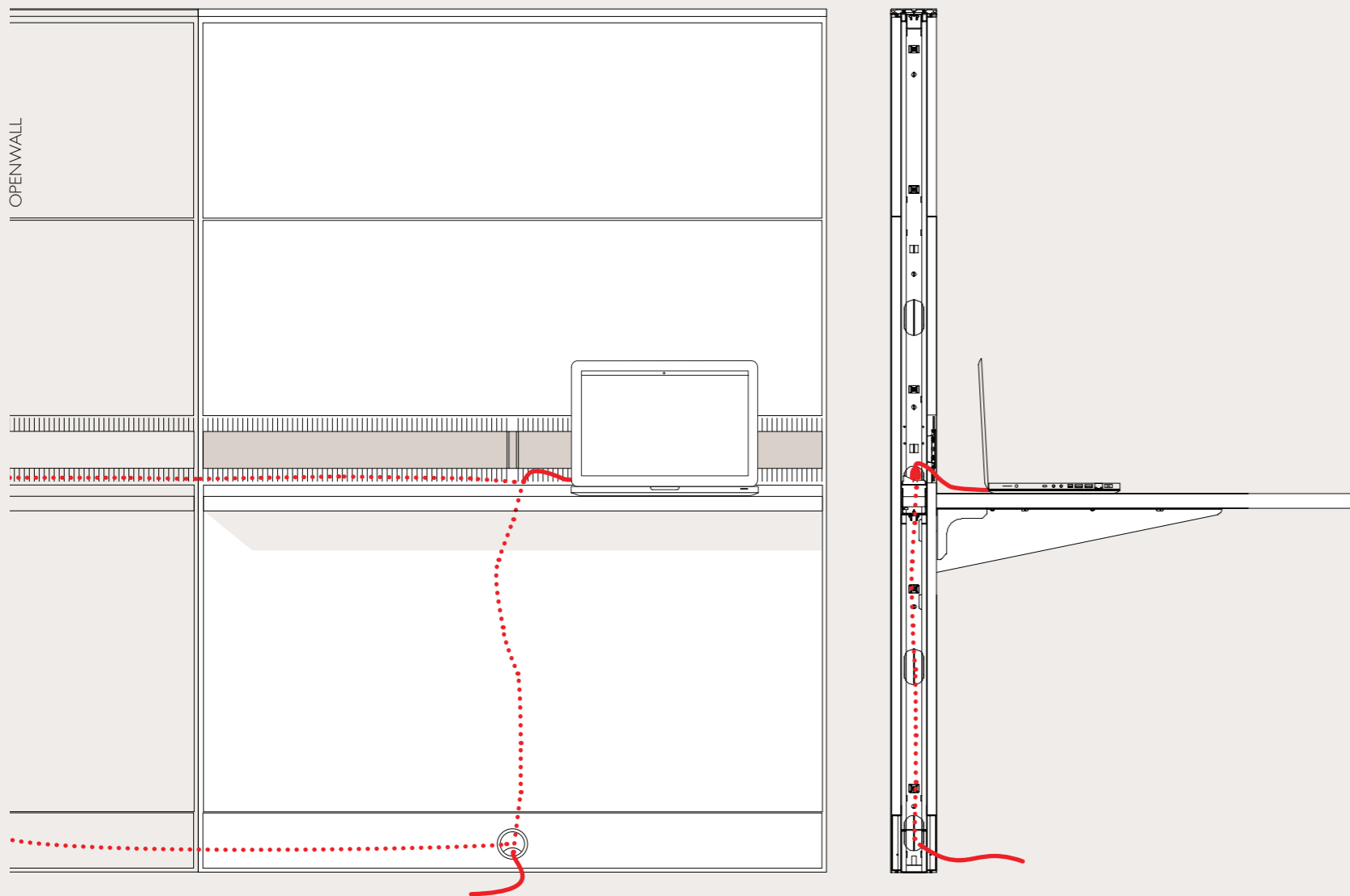

ANTE PASSACAVI  
DOORS FOR CABLES

L'anta che nasconde i cavi della canalizzazione può essere posizionata anche da un solo lato di un singolo modulo Openwall. L'anta passacavi FLIP di serie è basculante con apertura verso l'alto e verso il basso. Come optional, l'anta passacavi VELA con un sistema di apertura verso l'alto che offre la massima accessibilità al vano tecnico. All'interno la possibilità di alloggiare una speciale power unit kit per laptop o desktop, che garantisce maggior sicurezza dell'impianto elettrico e un efficace sistema di risparmio energetico.

The door which hides the cables can also be placed from one side only of a single Openwall module. The standard FLIP door for cables has tilting opening which opens upwards and downwards. As optional, the VELA opening system offers maximum access upwards to the technical compartment. The possibility to contain within a special power unit kit for laptop or desktop for greater electrical safety and an efficient energy saving system.

Anta passacavi FLIP  
FLIP door for cables



Anta passacavi VELA  
VELA door for cables

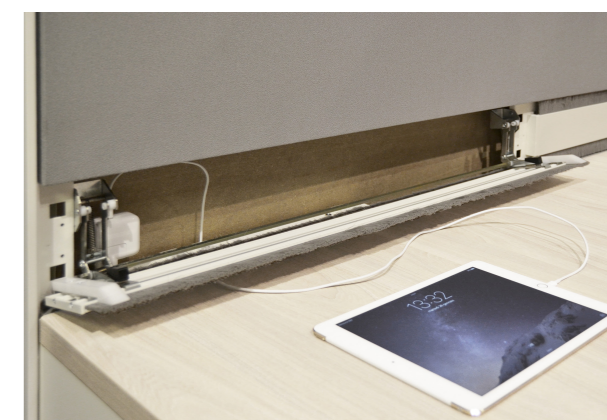

ACCESSORI  
SU PROFILO SUPERIORE  
ACCESSORIES  
ON UPPER PROFILE

Openwall può essere attrezzato con numerosi accessori funzionali per archiviare e personalizzare il proprio spazio di lavoro. La mensola metallica e il pensile sono agganciati al profilo superiore e possono essere liberamente posizionati su tutta la lunghezza della parete Openwall.

Openwall can be equipped with many functional accessories to store and customize the workspace. The metal shelf and the suspended cabinet are hanging on the upper profile and can be freely placed along the entire length of the Openwall module.

01.



02.



03.

01. Pensile con apertura a vela in metallo e serratura. Struttura in melaminico bianco.  
Come optional, barra led sottopensile 120 led/mt cablato con alimentatore ITA.

Metal suspended cabinet with tilt door and lock.  
Melamine white structure.  
As optional, under suspended cabinet led beam cabling 120 led/mt with power cable ITA.

02. Vista del vano interno del pensile porta dox.  
Inside view of the suspended cabinet for dox.
03. Mensola in metallo.  
Metal shelf.

ACCESSORI  
SU CREMAGLIERE  
ACCESSORIES  
ON RACKS

Il sistema a cremagliera integrato alla struttura è estremamente flessibile e versatile: ogni ripiano o accessorio è fissato con staffe, ciò permette di decidere la configurazione di ogni modulo Openwall al momento del montaggio e di variarne l'assetto anche in un secondo momento.

The rack system is extremely flexible and versatile: each shelf or accessory can be fixed by using brackets, this allows to decide the configuration of each Openwall module by the moment of assembling and to change it in a second moment.

04.



05.



04. Mensola melaminica con staffe su cremagliere.  
Melamine shelf with brackets on racks.
05. Barra in alluminio porta accessori H. 72 mm con staffe di fissaggio su cremagliere.  
Attrezzata con porta oggetti e porta penne in tecnopolimero bianco opaco.

Aluminium bar H. 72 mm for accessories with fixing brackets on racks.  
Equipped with matt white high-tech polymer objects and pens holder.

L'azienda si riserva in qualunque momento di apportare senza preavviso modifiche a prodotti, accessori e finiture.

The Manufacturer reserves the right to modify products, accessories and finishings at any time without prior notice.

**UNI** PROF products are according to UNI standard

 CEE standard

 low emission of formaldehyde

 productions process that respect the ambient

**CATAS**

**PROF**  
*Responsibility*

AD & graphic project  
RMDESIGNSTUDIO

design  
R&S PROF

visualization  
DELTA TRACING

Febbraio 2015

PROFESSIONAL OFFICE  
**PROF**

PROF srl  
Via Cao de Villa 6/A  
31020 Falzè di Piave, TV / Italy  
T. +39 0438 903190 F. +39 0438 903228  
p.iva / cod.fisc IT03134570260  
www.profoffice.it info@profoffice.it

